

LUX CORPORATION, JAPAN



**DIGITAL SYNTHESIZER
FM STEREO TUNER**

Laboratory Standard Series

T-14

OWNER'S MANUAL

CONTENTS

- SWITCHES & TERMINALS 2
- CONNECTION PROCEDURE 6
- TO MAKE THE MOST OF THIS TUNER .. 8
- TUNING PROCEDURE 10
- BLOCK DIAGRAM 11
- STANDARD CURVES 12
- SPECIFICATIONS 13

WARNING: TO PREVENT FIRE OR SHOCK HAZARD
DO NOT EXPOSE THIS APPLIANCE TO
RAIN OR MOISTURE.

Thank you for purchasing the T-14

In general, a quick and accurate operation is feasible with the tuner featured by the digital techniques, however, such equipment tends to be too mechanical as is represented by "computers". We decided to produce a high quality tuner that represents the most up-to-date digital techniques and is at the same time suitable as Audio Equipment. The result is the T-14 Frequency Synthesized FM Stereo Tuner designed to handle today's

high density of FM stations.

The T-14 represents the finest standards of design and craftsmanship, but the proof is in your handling --- and listening. As you proceed to connect the tuner, may we suggest that you read all the instructions carefully before turning the unit on? A few moments invested now can eliminate doubts or delays later. If you have any question, please do not hesitate to consult your dealer!



Switches & Terminals

1. Power Switch

The power switch is of an alternating push-on, push-off type. Press in this switch and AC power is supplied to the tuner and the Digital Frequency Indicator is illuminated. A time delay muting circuit is integrated to eliminate unpleasant "thump noise" at the time of turning the unit on, and sound reproduction will commence after approx. 1 second.

2. Preset Buttons

These buttons provide a dual function; to store a desired broadcasting station frequency and to recall the station once stored. Twelve buttons are provided to allow storage of 12 FM stations.

To store a station frequency, tune in to the desired station, then depress first the Store Switch (3) and then one of the Preset Buttons. To recall the stored station frequency, simply press the corresponding Preset Button.

3. Store Switch

To store frequencies of broadcasting stations. This switch should be used only to store a new station. Press-

ing this switch and subsequently a Preset Button (2) will erase the frequency stored previously. Thanks to a built-in Ni-Cd battery which recharges while the power is on, the station memory remains effective even when the tuner is switched off. If the T-14 is kept unused for a long period, the battery will discharge itself and the stored station frequencies may be erased. In this case, re-store the stations after battery is charged.

4. Preset Indicators

When selecting a stored station, the indicator pertaining to the Preset Button(2) lights up.

5. Store Indicator

When the Store Switch (3) is depressed, the LED indicator lights up to show that it is ready to store new FM broadcasting stations.

6. Signal Strength Indicator

Indicates the signal strength of the tuned-in broadcasting station. When 3 or more LED's light up, the signal is

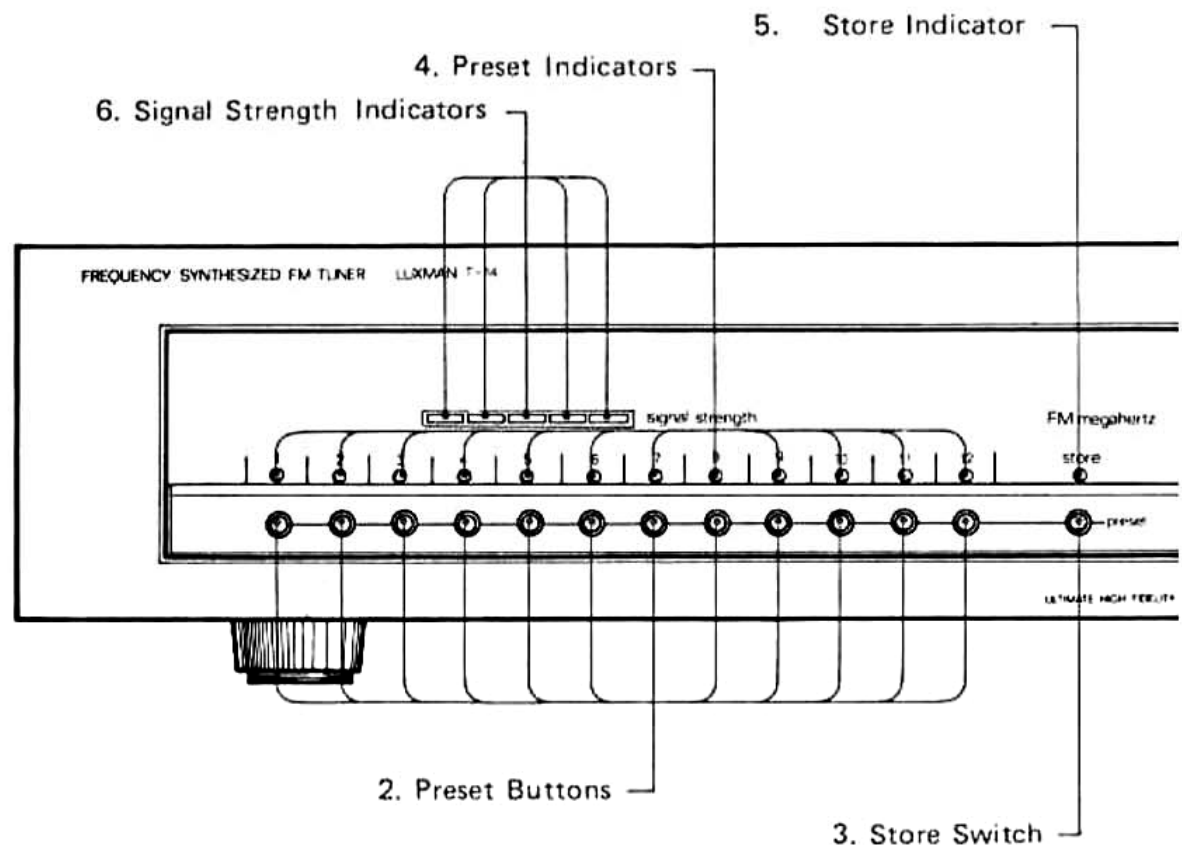

strong enough for stereo reception.

7. Digital Frequency Indicator

Indicates the receiving frequency in digital mode. The receivable frequency from 87.55 to 108.00 MHz is indicated in 50 KHz increments.

8. Stereo Indicator

The indicator lights up to identify stereo FM reception when the Monaural Switch (10) is in the "protruded" position. FM stereo broadcasting of impractically low level is automatically received in monaural mode and accordingly the indicator does not light. When the Monaural Switch (10) is depressed, stereo broadcasting is received in monaural mode and the indicator does not light.

9. IF Bandwidth Selector Switch

This switch is provided to realize either the low distortion characteristic which aims to improve sonic quality, or the high selectivity characteristic to ensure clear reception. The switch is of an alternate push-on, push-off type. In the "protruded" position, the IF bandwidth is "WIDE", and the selectivity at ± 400 kHz becomes 40 dB to

realize low distortion. When it is depressed, the bandwidth is "NARROW" to provide 80 dB selectivity at ± 400 kHz, which is effective to eliminate disturbance by an adjacent station.

10. Tuning Selector Switch

This switch selects between "automatic" (protruded) and "manual" (depressed) tuning.

11. Monaural Switch

Usually this switch should be in the "protruded" (stereo) position. When it is depressed (mono), the mode is changed into monaural reception only. Use this position if you want to listen to a stereo broadcast in monaural mode or if the signal strength is too weak to permit adequate stereo reception.

12. Tuning Keys

These keys select broadcasting stations. Pressing-in the left key makes the receiving frequency go down. The right key increases the frequency.

In the case of manual tuning, a slight touch to the key makes the frequency go up or down in 50 kHz

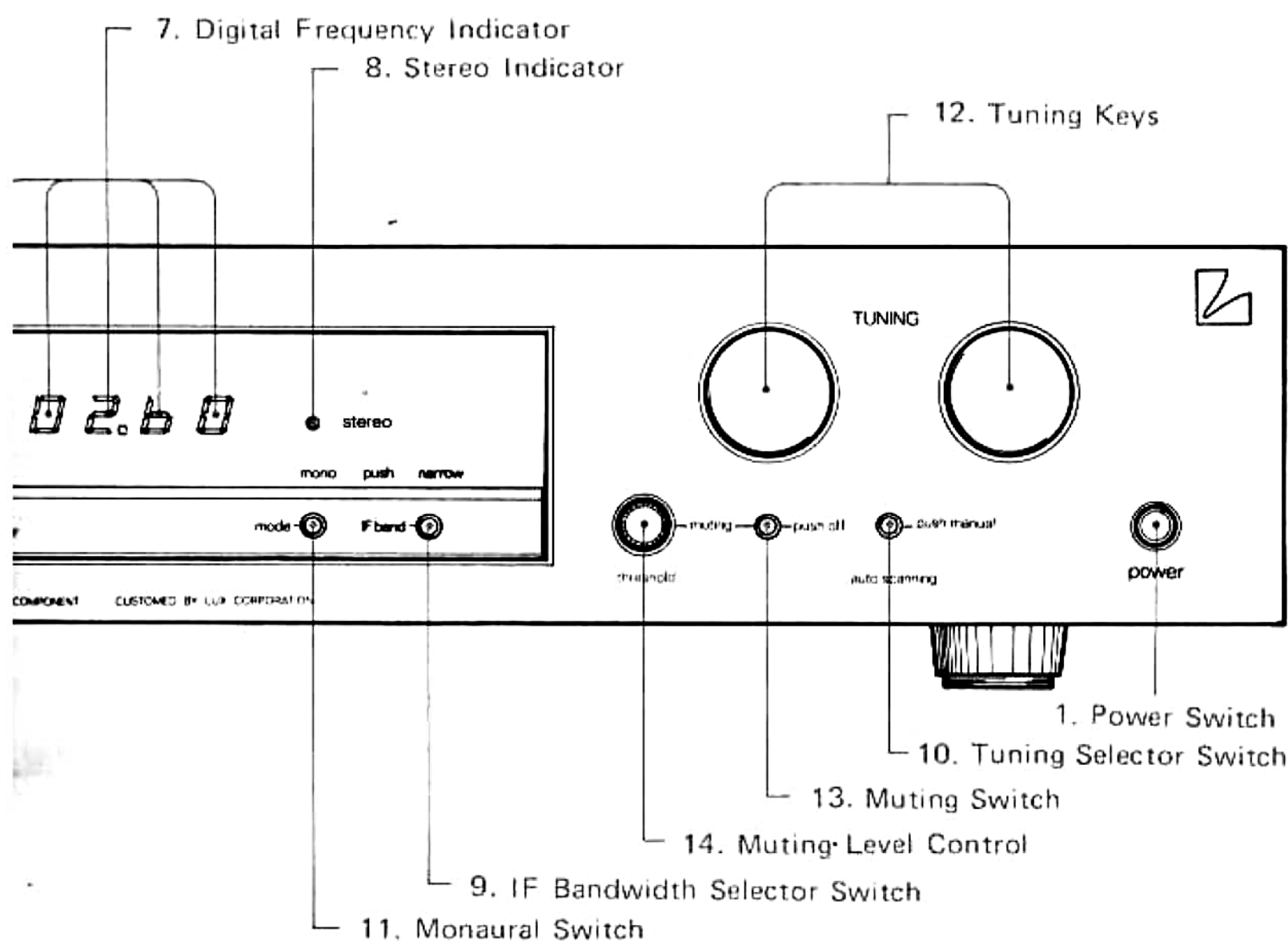

increments. When the key is kept depressed, the frequency changes continuously by 50 kHz, and tuning stops when your hand is released from the key. In case tuning stops at an inaccurate point, press either of the keys slightly and adjust the frequency to obtain accurate receiving frequency. Note that, in this case, tuning stops at the end of the band, therefore press the reverse-direction key to continue the tuning operation. The tuning speed is maintained at a rate determined by the Scanning Speed Adjuster (15), therefore you can watch and confirm the exact tuning.

In the case of automatic tuning, a slight touch of the key makes the receiving frequency automatically shift, and the tuning function ceases at the broadcasting station whose signal strength exceeds the pre-fixed muting level. Repetition of the same operation is necessary until the desired station is obtained. At the end of the band tuning is reversed automatically to the other direction. When a certain broadcasting station is approached, the tuning speed is slowed down a little, since the tuner judges if it is a broadcasting station, and if the signal

strength is suitable to realize satisfactory reception. Upon confirmation that the reception is suitable for the practical use, tuning function stops in order to receive the station signals.

13. Muting Switch

This switch removes the interstation noise peculiar to FM broadcasting which occurs when tuning is shifted out of the correct tuning point. The output circuit is turned on or off by use of a relay, therefore pleasant muting operation is feasible without switching thumps. When the switch is depressed, the muting circuit is bypassed, and relatively weak signals can be received.

Note that at the normal unpressed position the muting level can be pre-adjusted by the Muting Level Control (13). But at the time of automatic tuning, the muting circuit functions irrespective of the muting switch.

14. Muting Level Control

This control is provided to determine the muting threshold level and is operated when the Muting Switch (13) is kept unpressed ("on").

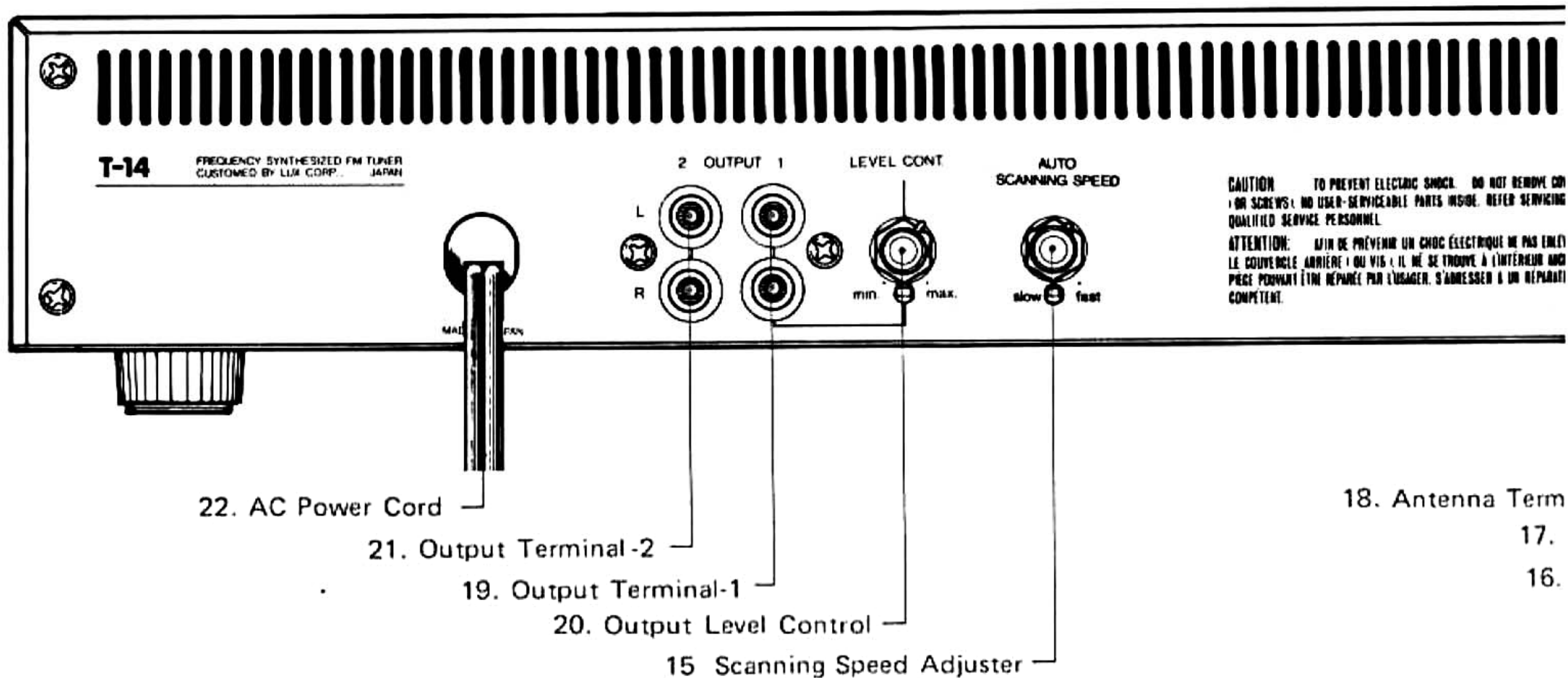

In the "min" position, the muting level is set to approximately $10\ \mu\text{V}$ while in the "max" position, it is approx. $100\ \mu\text{V}$. Within this range, you can adjust the muting level freely at your choice. Sometimes, the electric field fluctuates depending on the propagation route of signal waves, and reproduced sound comes out intermittently. In this case, the muting level is set rather too high; turn it towards the left direction to obtain stable receiving condition.

Note that the Stereo Indicator (7) is always controlled by the muting level thus adjusted and that the Muting Switch (12) has nothing to do with it. In other words, when the tuner receives a signal that is weaker than the preset muting level, the stereo indicator does not light up, irrespective of the position of the muting switch.

15. Scanning Speed Adjuster

The tuning speed, that is, the rate of change of received frequencies, can be adjusted by this function.

Turn the knob to obtain the optimum tuning speed. Turning counter-clockwise slows down the speed, while

turning clockwise accelerates it.

16. Coaxial Antenna Connector (75 ohms)

Many FM antennas are provided with the 75-ohm terminal. Use 75-ohm coaxial cable to connect the FM antenna to this connector.

When this connector is used, an F-type connector provided should be fixed to the coaxial cable. The F-type connector makes it easy to connect the cable to the T-14 without using solder.

As for connection, refer to the section "How to Use Coaxial Connector".

17. Antenna Terminal (75 ohms)

Function of the terminal is identical to that of the Coaxial Connector (16). Use this terminal for connection of an FM antenna with 75-ohm coaxial cable as lead-in wire.

Connect the inner conductor to the 75-ohm terminal (right) and the outer shield wires to the GND terminal (left).

18. Antenna Terminal (300 ohms)

Connect the attached Dipole Antenna or an FM antenna of 300 ohms to this terminal.

19. Output Terminal-1

Normally, the output signals of the T-14 can be taken out from this terminal. Connect the terminal to the "TUNER" terminal or to the "AUX" terminal of an audio amplifier.

The Output Level Control is coupled to this terminal, and suitable reproduction level can be obtained to match that of other audio components.

20. Output Level Control

This control is provided for the Output Terminal-1 (19) to permit output level adjustment in the range of 0 V to 1 V. An extreme clockwise turn provides the maximum 1 V output, while an extreme counter-clockwise turn reduces the output to 0 V.

21. Output Terminal-2

Same use as the Output Terminal-1 (18), except that constant output (max. 1 V) is always obtainable.

22. AC Power Cord

Plug the power cord into an appropriate AC outlet in your listening room, or into an extra AC Outlet (SWITCHED) of an amplifier. In the latter case, switching ON or OFF of the T-14 can be made by the power switch of the amplifier. The power consumption of the T-14 can be made by the power switch of the amplifier. The power consumption of the T-14 is 15 watts.

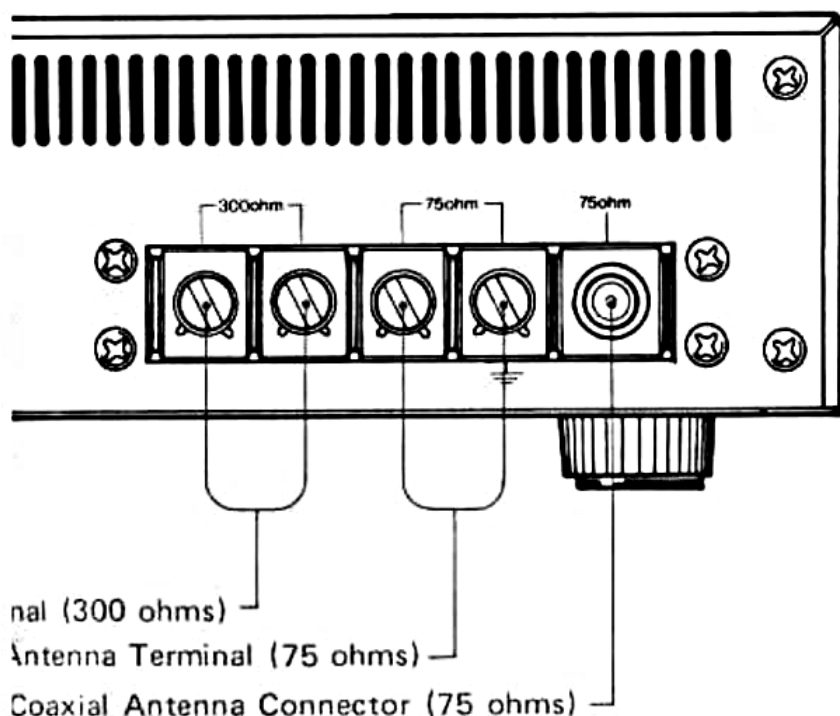

Connection Procedure

Connection of Antenna to Antenna Terminals

3 different Antenna Terminals are provided; the Coaxial Connector (75-ohm) (16), the Antenna Terminal (75-ohm) (17) and the Antenna Terminal (300-ohm) (18). Select an appropriate terminal, considering the impedance of the antenna connected and that of the lead-in cable. For the connection procedure, refer to the illustration.

Connection of Outputs to Audio Amplifier

Connect the output terminals (19) or (20) to the TUNER or AUX terminals of an audio amplifier by means of pin jack cord. Left channel output must be connected to left channel input, and so with the right channel. Since the output terminal (18) is coupled with the Output Level Control (20), use of this terminal is normally recommended.

AC Power Cord

Plug the AC Power Cord (21) into an appropriate AC wall socket, or the AC outlet of an audio amplifier. Switch on the AC Power Switch (1) and the Digital Frequency Indicator lights up. Then in about 1 second, the T-14 is put into the operational condition, since a time-delay muting circuit is provided to prevent the unwanted switching thumps.

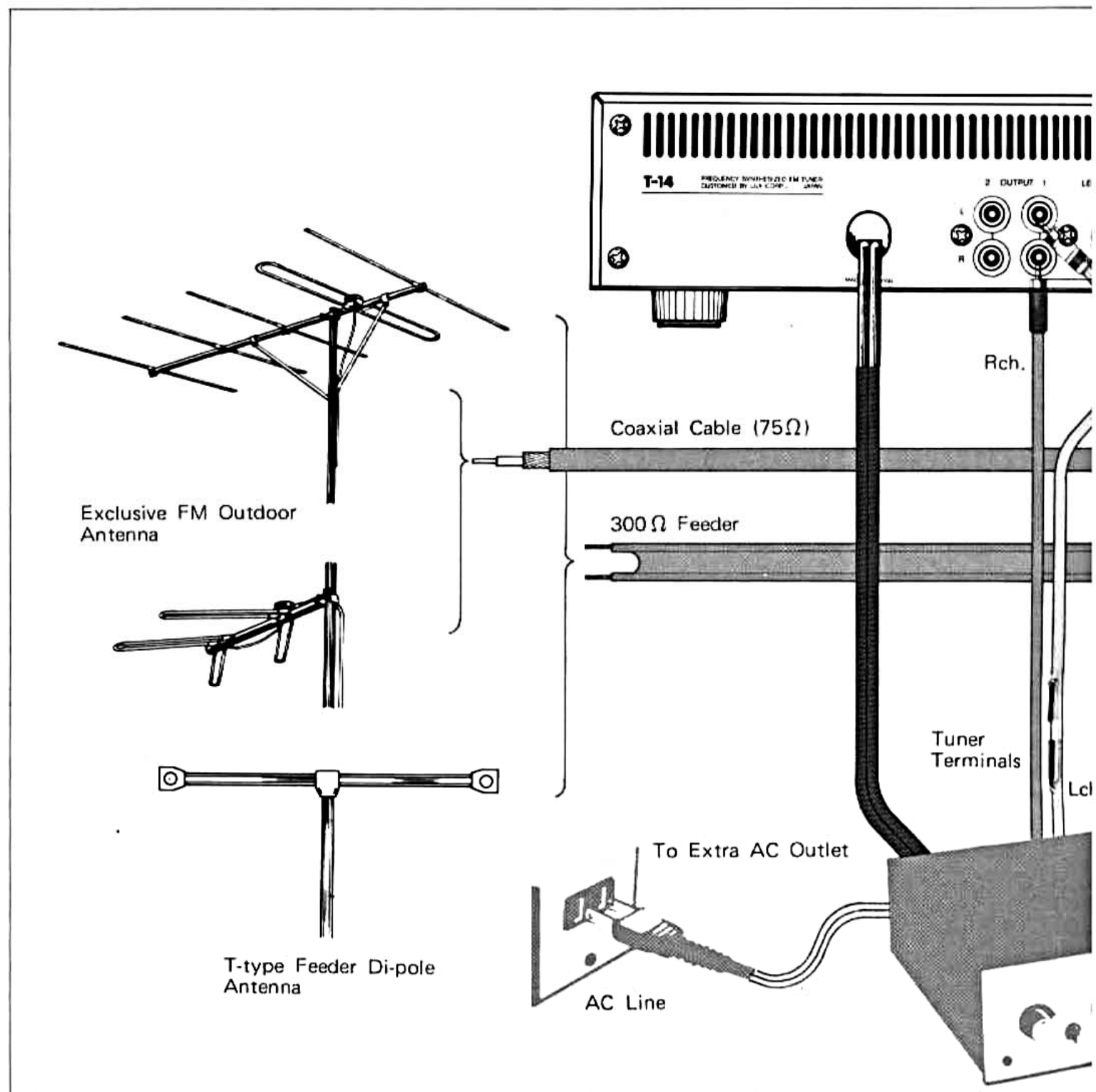

[HOW TO USE COAXIAL CONNECTOR]

As shown in the Figure 1, peel off the outer cover and insert the projected section of the connector in between the shield wire and the core conductor cover. Then firmly fasten the aluminum ring, as shown by the Figure 2, by means of plier.

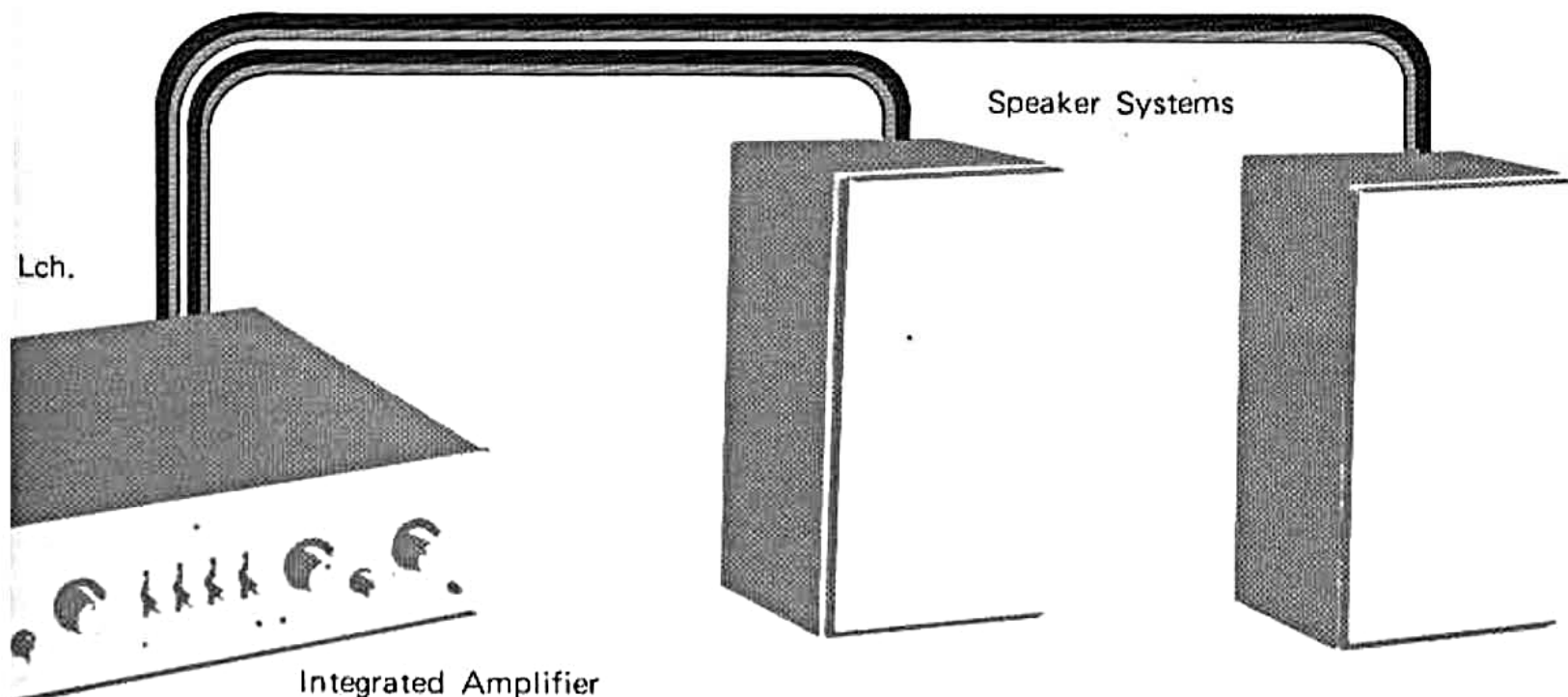
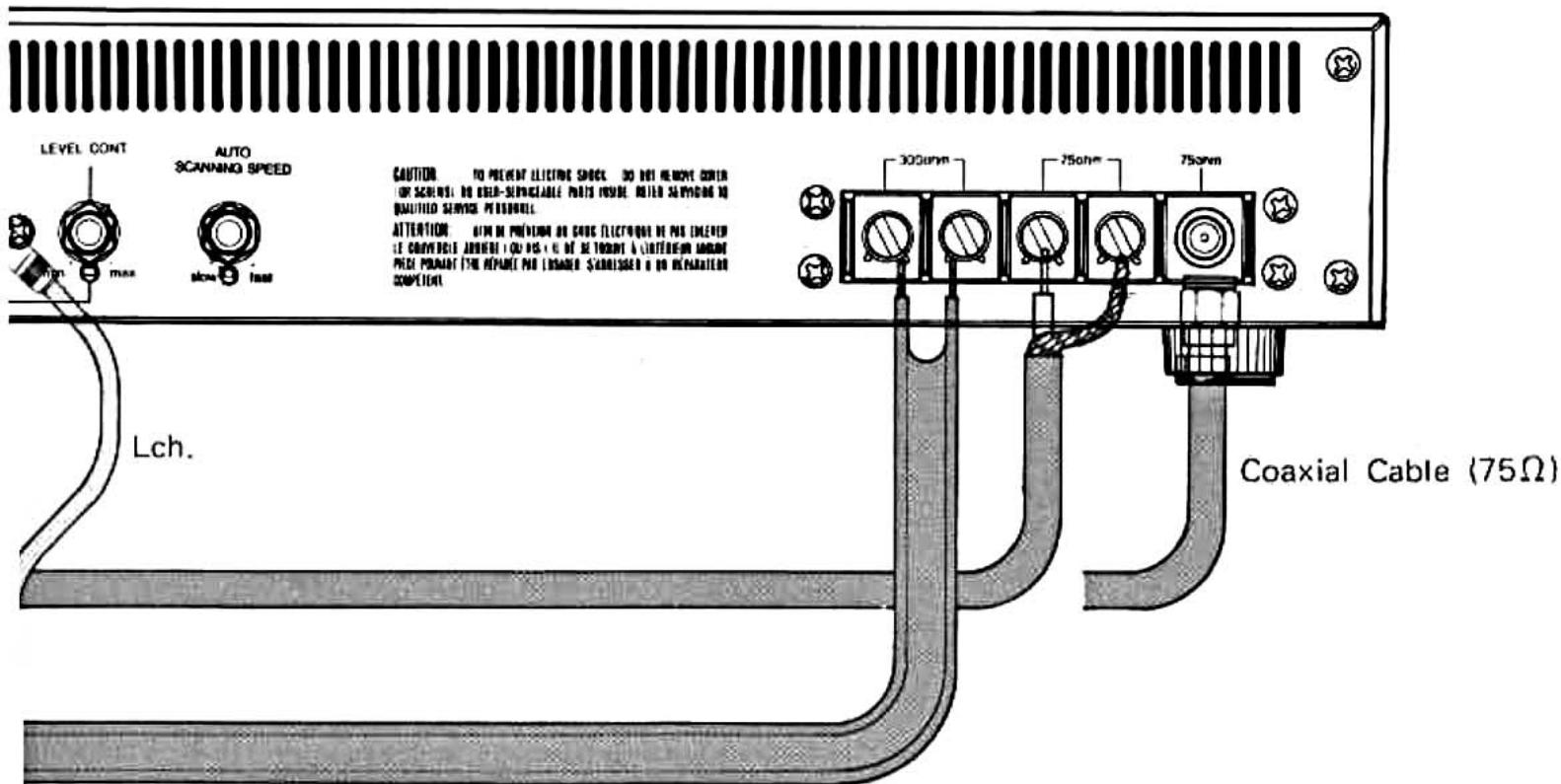
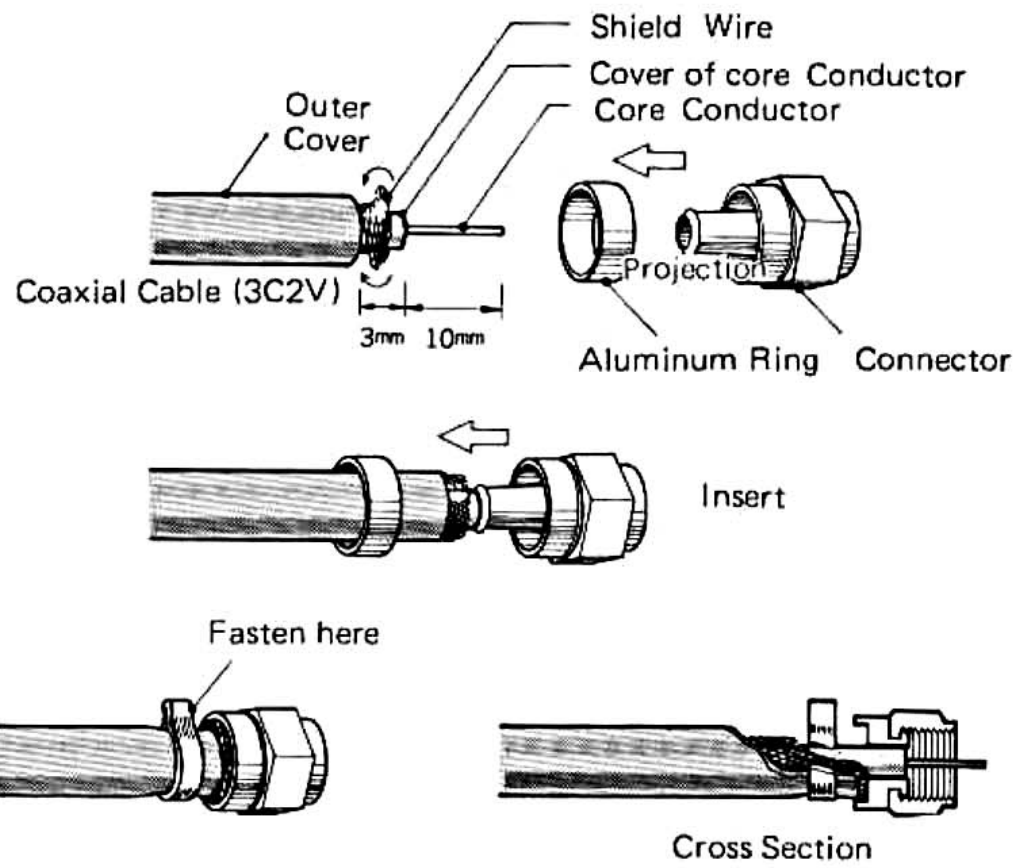

To Make the Most of This Tuner

FM ANTENNA

The greatest advantage of FM broadcasting is that playback sound is superior to that of AM. However, because of the inherent characteristics of FM broadcast frequencies (VHF band), even when a high quality tuner is used, incorrect selection of antenna and its feeder cable may easily impair the advantage of FM. The FM antenna system must be set up taking into account the electric field strength, multipath problems, noise sources, tuner location and so forth.

SELECTION OF FM ANTENNA [Field Strength]

When receiving FM broadcasts from distant stations, it is necessary to use a highly sensitive tuner to improve S/N ratio. However, if the FM antenna was inadequately selected, a user cannot take the advantage of such high sensitive tuner. For instance, a comparison of the following tuner/antenna combination was made:

- (1) a tuner having IHF sensitivity of $1.7\mu\text{V}$ plus a simple single feeder antenna (a type of whip antenna).
- (2) a tuner having IHF sensitivity of $2.5\mu\text{V}$ plus an exclusive 3-element FM antenna.

Results showed that the latter combination gave better reception. This is because such a simple single feeder antenna has a negative gain while an exclusive FM antenna has a positive gain. The gain factors of such exclusive FM antenna are, 3-4 dB with 2 elements, 4-5 dB, 3 elements, 5-7 dB 5 elements and 6-8 dB, 7 elements.

As the antenna gain is increased in proportion to the number of antenna elements, selection of optimum FM antenna can be determined by consideration of field strength of FM wave where the tuner is installed. Needless to say, your audio shop will gladly assist you for optimum selection of the antenna.

In summary, where far from broadcast stations, high gain antennas are needed. If field strength is sufficiently strong, good reception is possible with the di-pole antenna (T-type) provided.

[Multipath Measures]

The terms multipath refers to the multiple paths of FM radio waves reflected by mountains, buildings, etc. that are received by an antenna besides the waves arriving directly from broadcast stations. This phenomenon is inevitable because of the inherent nature of VHF (very high frequency) transmission waves. In the case of a television receiver, presence of multipath is visibly recognized by so-called "ghost" phenomenon and everyone is aware of the importance of proper

setting of TV antenna. However, in the case of FM reception, multipath problems may only be perceived as deteriorated playback of stereo sound.

Very frequently, such deterioration is attributed to the program source. Correction of multipath problems can sometimes be made by use of an FM tuner having excellent limiter characteristics, but normally there would be no other measures than to provide an optimum FM receiving condition by selection of antenna, location, direction, height, etc. An effective way to filter harmful multipath waves coming from all conceivable directions by reflection, and to catch the direct wave only, is a use of directional FM antenna as explained in the "Field Strength" section of this manual.

Since such antennas not only possesses gain but also directivity, when it is directed to broadcast stations, it filters out waves coming from other directions. The directivity sharply increases as the number of antenna element increases. When sharp cut-off of multipath waves is desired, use of an antenna having more elements is necessary. The standard di-pole antenna (T-type) has such directivity as may be described by the numeral "8". This means when multipath waves come from the opposite direction of broadcast stations it is subjected to multipath influence. To the horizontal direction (parallel to antenna leads), since gain is lowered, multipath waves coming from that direction can be filtered. With this knowledge, the di-pole antenna may be very useful.

The whip antenna which is provided for portable transistor radios has no directivity. This means where multipath is present, it is completely subjected to its influence.

Measures against multipath trouble must be taken after verifying the cause of multipaths occurrence by which optimum measures can be known - - - use of directional antenna such as exclusive FM antenna, standard di-pole antenna, etc. and also its correct placement and setting up. If multipath problems are present at a place close to broadcast stations (sufficient field strength), it is suggested that you procure a 2 element compact FM antenna at an audio shop. This antenna has little or no gain but has very good directivity and is optimum for reducing multipath measures at a location having strong field strength. When using a standard di-pole antenna (provided as accessory), it is also recommended to set it outdoors in order to avoid possible influence of metallic accessories such as curtain rods, etc., not to speak of steel used in ferro-concrete structure.

LOCATION OF FM ANTENNA

Any good FM antenna cannot exhibit its designed performance if it is erected incorrectly --- too low or hindered by surroundings. The FM antenna must be at least 4 meters (14 feet) high from the ground level and clear of surrounding obstacles for 3 meters (10 feet) or more. To prevent possible pick-up of car ignition noise, or any other high frequency noises, the antenna must be set up as far as possible from such noise generating sources.

ANTENNA CABLE

[Selection of Cable and Connection]

Selection of cable and its connection is important as well. There are two types of FM antenna cables, one is the ribbon feeder antenna having 300-ohm impedance and other is the coaxial cable having 75-ohm impedance.

The 300-ohm ribbon feeder cable is identical to what is used for the standard di-pole antenna provided, and it can be used for extension of the di-pole antenna for connection to the 300-ohm FM antenna terminals.

In case 75-ohm coaxial cable is

used, connect the exclusive terminal for coaxial cable of the FM antenna and the Coaxial Connector (16) or the Antenna Terminal (75-ohm) (17).

The 75-ohm coaxial cable is more stable than the 300-ohm ribbon feeder against environmental (weather) conditions. Also, it is less influenced by external electrical noise, and the impedance is quite stable even if it is located in the vicinity of metallic obstacles. Therefore, we recommend that you use this coaxial cable in case you think the ribbon feeder type is inadequate.

[Cable Wiring]

The antenna cable must be placed carefully. Avoid placing it near or in parallel to conductive substance as this causes the cable impedance to vary. Coaxial cable has more stable characteristics against various environmental conditions inclusive of weather and it is less influenced by external noise sources. The insertion loss of the ribbon feeder is 0.45 dB per 10 meters (33 feet) for the FM band, while the coaxial cable, type 3C2V which is most commonly used, is 1.35 dB. Therefore, the shorter the cable length, the better the result.

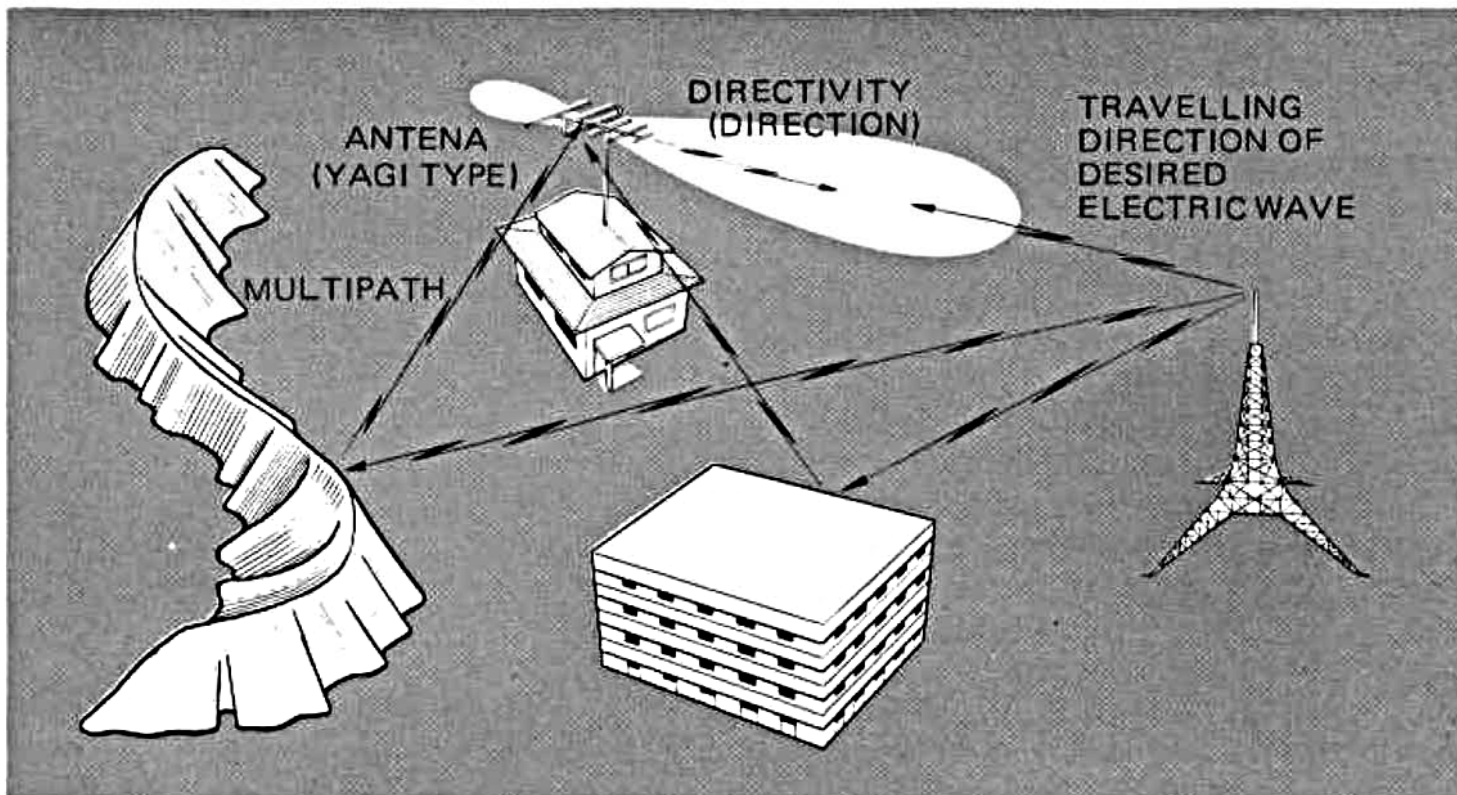
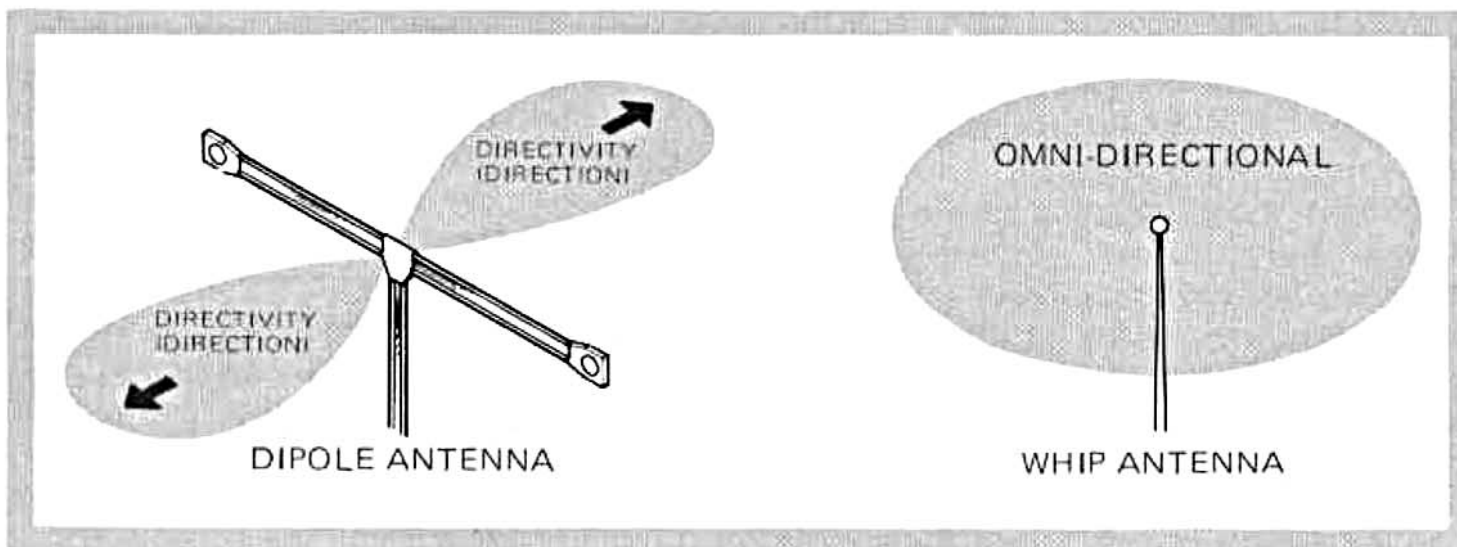

Tuning Procedure

Manual Tuning

Manual tuning is possible when the Tuning Selector Switch is depressed. This is useful to realize speedy tuning in case the receiving frequency of your desired station is unknown.

Two buttons are provided as the Tuning Key. The left lowers the receiving frequency and the right one raises it. By operating these two buttons, you can expect the same effect as tuning by use of a conventional tuning knob. The receiving frequency is changed in 50 kHz increments by slightly pressing the Tuning Key. When it is kept pressed on, it changes at the preset speed adjusted by the Scanning Speed Adjuster(15). When the indication shows the receiving frequency of your desired broadcasting station, release your hand from the button, and desired reception is feasible.

In the course of tuning operation when indication runs over or short of the desired receiving frequency, obtain the accurate frequency by pressing either of the two buttons.

In the case of manual tuning, note that tuning indication stops at the end of the FM band. Therefore, press the button for reverse direction to continue tuning operation.

Auto Tuning

Auto tuning is possible when the Tuning Selector Switch is in the "protruded" position. This is an important feature of the Frequency Synthesized Tuner, and is useful in searching for a broadcasting station whose frequency is unknown.

A slight touch of either of the two Tuning Keys makes the receiving frequency automatically vary, and the tuning function stops at the next broadcasting station, (which meets the reception mode set by the Monaural Switch and exceeds the given muting level). Repeat the same operation until the desired station is received.

In the case of auto tuning, the tuning procedure will be repeated automatically at the end of band.

Memory Tuning

The memory system adopted here is constructed of a pure electronic circuit, and C-MOS IC is utilized as a memory-element. Therefore, storage of desired station or its alteration is easy. Also, the system offers quite stable memory tuning operation unlike the mechanical memory system that is unstable against fluctuation of ambient conditions such as temperature or moisture. Of course, once storage is made, it will not be erased even if the AC power is turned off. The memory tuning function is one of

the most outstanding features of the frequency synthesized tuner.

[How to store broadcasting station frequencies]

First, set the Tuning Selector Switch (10) either in the "protruded" (auto) or "depressed" (manual) position, and tune in to a station. Press in one of the 12 Preset Buttons (2) after depressing the Store Switch (3). Totally 12 stations can be stored.

This simple operation made it possible to store a new station frequency perfectly, even if a station is pre-memorized.

Note that the Store Switch should be used only when new storage of stations is needed, since when the Preset Button is depressed while with the Store Switch pressed in, the stored station is erased off, although simple operation of the Preset Button itself does not matter. That is to say, the Store Switch has a function equivalent to the recording button of tape-decks.

[How to recall the stored station]

One of the 12 broadcasting stations to which you are going to listen can be instantly recalled by a simple "press-in" operation of the appropriate Preset Button (2).

Battery for Memory Circuit

A battery to activate the memory circuit is installed inside the chassis to prevent the stored station frequencies from being erased. This battery is so designed as to be always charged while the Power Switch is "on". And in case this equipment is kept unused for a long period, the battery will discharge by itself and consequently the stored station frequencies may be erased. In this case, re-storing is possible after the battery is charged.

Block Diagram

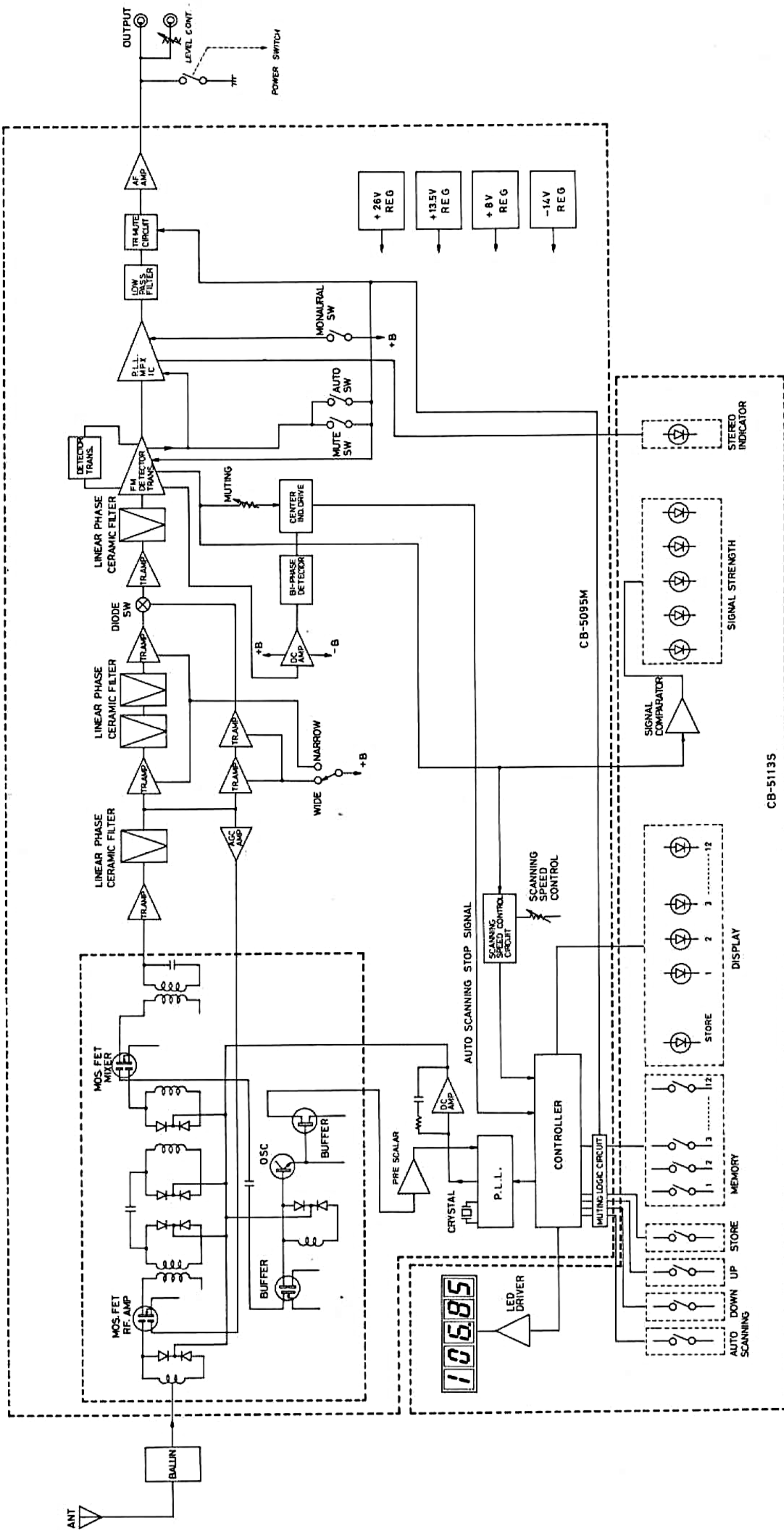

CB-51135

Standard Curves

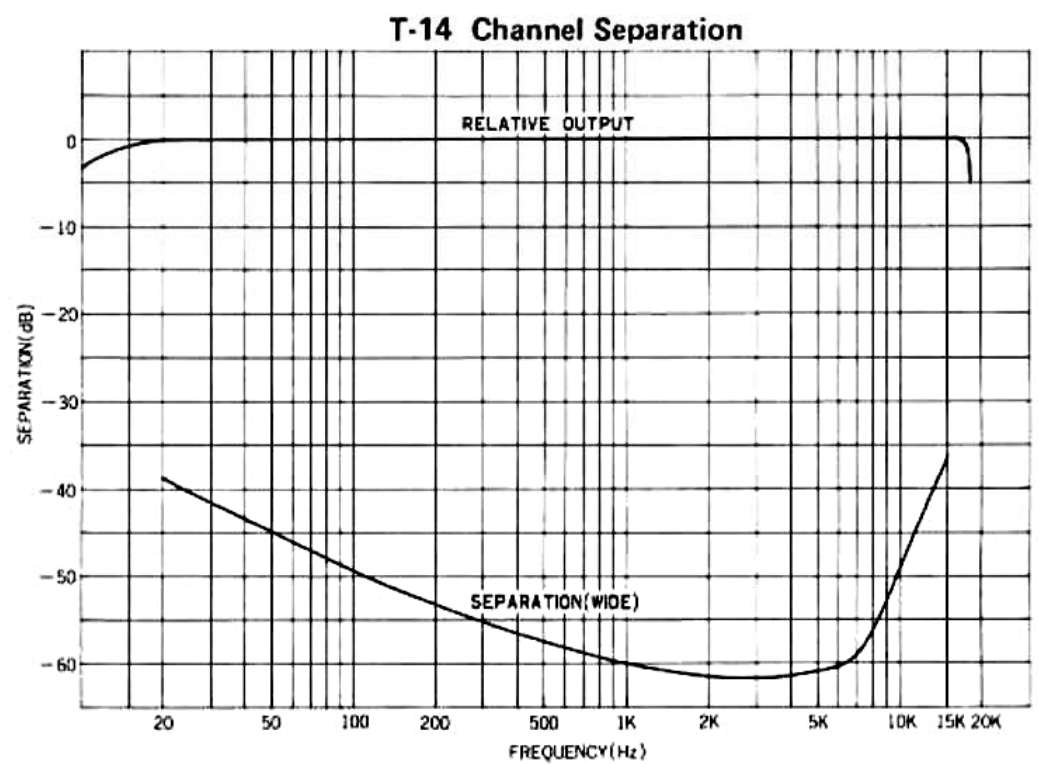
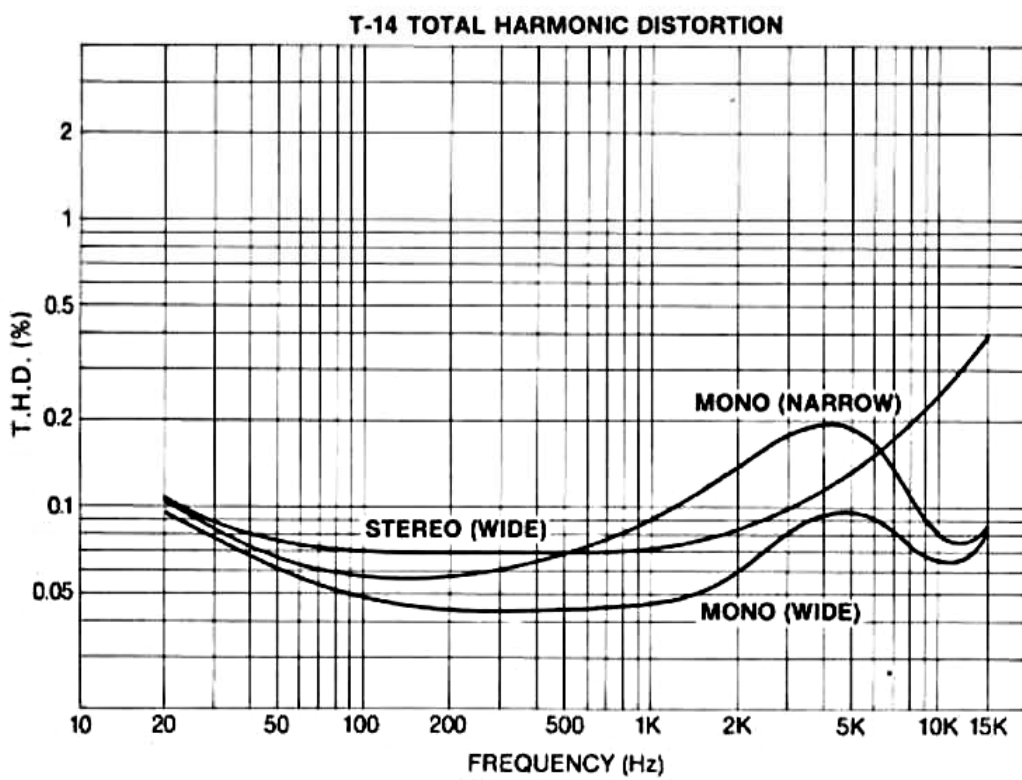
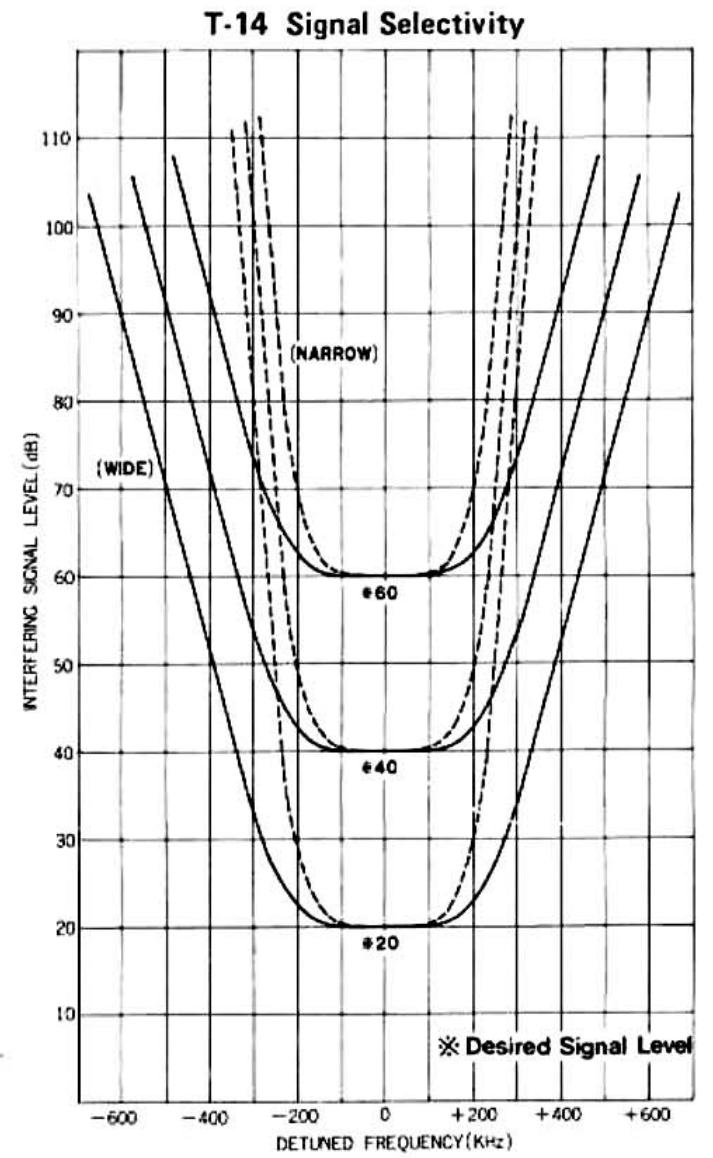
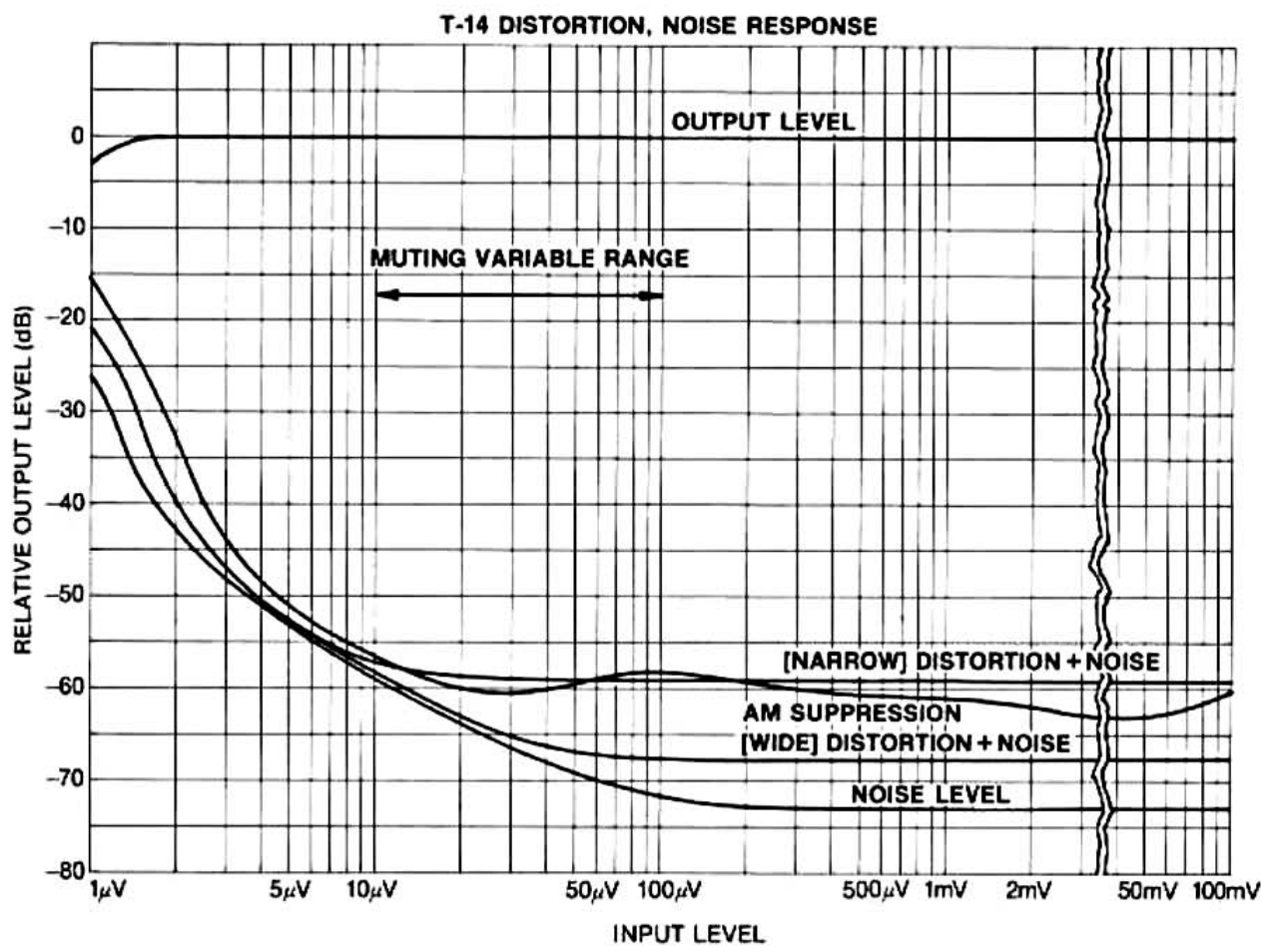

Specifications

Receiving Frequency:	87.55MHz – 108MHz (in 50kHz increments)	
50dB Quieting Sensitivity:	16.6dBf (3.7 μ V)	
IHF Usable Sensitivity:	10.3dBf (1.8 μ V)	
Signal to Noise Ratio:	72dB	
Frequency Response:	30Hz – 15kHz (\pm 1dB)	
Total Harmonic Distortion:	(mono)	(stereo)
	100Hz	0.08% (wide) 0.2% (wide)
	1kHz	0.08% (wide) 0.15% (wide)
	6kHz	0.15% (wide) 0.3% (wide)
	1kHz	0.2% (narrow) 0.5% (narrow)
Capture Ratio:	1.0dB (wide), 2.0dB (narrow)	
Alternate Channel Selectivity:	80dB (narrow \pm 300kHz) 40dB (wide \pm 400kHz)	
Adjacent Channel Selectivity:	10dB (narrow \pm 200kHz)	
Spurious Response Ratio:	95dB	
IF Response Ratio:	95dB	
Image Response Ratio:	100dB	
AM Suppression Ratio:	60dB	
Stereo Separation:	100Hz	45dB (wide)
	1kHz	48dB (wide), 30dB (narrow)
	10kHz	38dB (wide)
Subcarrier Product Ratio:	65dB	
SCA Rejection Ratio:	60dB	
Output Impedance:	100 ohms	
Muting Threshold:	10 μ V – 100 μ V (variable)	
Weight	Net	6.5kgs (14.3 lbs.)
	Gross	8.0kgs (17.6 lbs.)
Dimensions:	438 (W) x 350 (D) x 78 (H) mm (17-1/4" x 13-3/4" x 3-1/16") (including legs and rear protrusions)	

Specifications and appearance design subject to change without notice.